

Restoration & Moisture & Ventilation

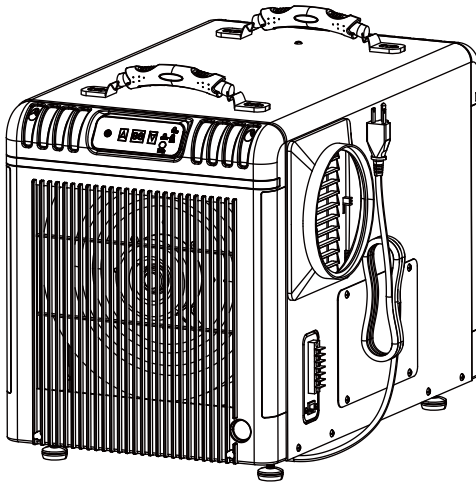

Sentinel HD90

Installation and Operations Manual



AlorAir Solutions INC.

Add: 14752 Yorba Ct Chino CA 91710 US

Tel: 1-888-990-7469

E-mail: sales@alorair.com

Specifications subject to change without notice.

Table of Contents

Warranty Registration	2
Safety Notes	2
Identification	3
Electrical Supply	3
Principle of Operation	3
Installation	3
Key Functions	5
Indicator Lights	6
Remote Control	7
Operating Instructions	8
Diagram	8
Maintenance	9
Dehumidifier Storage	9
Ducted Applications	9
Troubleshooting	11
Spare Parts	11
Warranty Information	12

Warranty Registration

Congratulations on purchasing a new Sentinel HD90 Dehumidifier. Your new dehumidifier comes with an extensive warranty plan. To register, simply fill in and return the warranty card provided in your dehumidifier box.

Be sure to note your dehumidifier serial number as you will need it for registration.

Safety Notes

- The Sentinel Series Dehumidifier must always be connected using a grounded electrical connection (as required for all electrical appliances). If non-grounded wiring is used, all liability reverts to owner and the warranty is voided.
- Sentinel Dehumidifiers should only be maintained and repaired by a qualified technician.
- Sentinel Dehumidifiers are only intended for operation when oriented with the unit sitting on its feet and level. Operating the unit in any other orientation could allow water to flood electrical components.
- Always unplug the dehumidifier before moving.
- If there is a chance that water flooded the dehumidifier, it should be opened and allowed to dry thoroughly before reconnecting to electrical power and restarting.
- To ensure proper operation, neither the inlet nor discharge should be positioned against a wall. The inlet requires a minimum of 12" clearance and the discharge requires a minimum of 36" clearance.
- The best option for proper diffusion of air throughout the room is to have the discharge blowing away from a wall and the inlet pulling air in parallel to a wall.
- Do not insert your fingers or any objects into the inlet or discharge.
- All work on the dehumidifier should be done with the unit "off" and unplugged.
- Do not use water to clean the exterior. To clean unit, unplug from power, then use a damp cloth to wipe the exterior.
- Do not stand on machine or use as a device to hang clothes.

Identification

For future reference, write down the model, serial number, and date of purchase for your dehumidifier. This is extremely helpful if you need to seek assistance in the future. The data label on the side of your unit has the key characteristics of your specific unit.

Model Number: Sentinel HD90

Serial Number: _____ **Date of Purchase:** _____

For additional questions concerning your dehumidifier, the following options are available:

- Contact your installing contractor
- E-mail:sales@alorair.com

Electrical Supply

Power Supply: 115 V, 60 Hz AC, Single Phase

Outlet Requirement: 3-Prong, GFCI

Circuit Protector: 15 Amps

WARNING: 240 Volts AC may cause serious injury from electric shock.

To reduce risk of injury:

1. Disconnect electrical power before servicing.
2. Only plug unit into grounded electrical circuit.
3. Do not use an extension cord.
4. Do not use a plug adapter.

Principle of Operation

The Sentinel Series Dehumidifiers utilizes its integral humidistat to monitor the conditioned space. When the relative humidity goes above the selected set point, the dehumidifier will energize. Air is drawn across an evaporator coil, which is cooler than the dew point of air. This means moisture will condense out of the air. The air is then reheated through the condenser coil and distributed back into the room.

Installation

The area to be controlled should be sealed with a vapor barrier. If unit is installed in a crawlspace, all vents should be sealed.

Key Functions

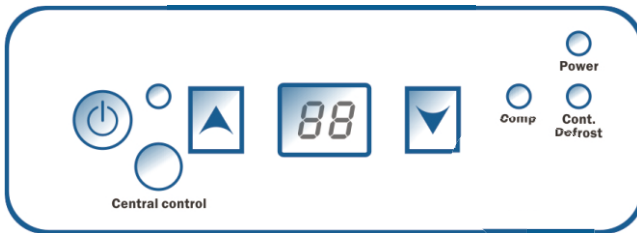

1. Power Key

- Use this button to turn the dehumidifier on and off. Press once to turn machine on .

You will hear two beeps and the  light will illuminate green, Press the power button a second time and you will hear one beep as the machine shuts down. Note that there is a one minute fan delay on shutdown.

2. Arrow Buttons

- Use the up and down arrow buttons to set the desired humidity setpoint on the display screen.  The setpoint can be any number between 36-90%. Creating a set point means that when the indoor humidity is lower than the set point, the machine will stop automatically. Conversely, when the indoor humidity is higher than the set level, the unit will operate. **NOTE: The humidity levels displayed are approximate only (+/- 5%).**

3. Continuous Mode

- To switch into continuous mode, set the humidity below 36%. At this point the Cont. light should illuminate green on the display board to indicate you have successfully switched to continuous mode. The display screen will show "CO".
- When set to continuous, the dehumidifier will run constantly, regardless of the humidity level. To stop the dehumidifier from running, turn the unit off or switch back to normal humidistat operation. To switch back to normal humidistat operation, simply move the setpoint above 36%.

WARNING: Do not install your dehumidifier in a corrosive environment. Some liquid vapor barriers dry via “solvent evaporation”. Always make sure that barrier is completely dry and area is thoroughly ventilated before installing dehumidifier.

Step #1: Place dehumidifier on a level surface.

If the unit is handled in such a manner that the compressor did not remain in the upright position, you will need to place it on a level surface and wait a minimum of 2 hours before turning the unit “on”.

NOTE: Do not place directly on vapor barrier. Elevation is required to allow the condensate water to drain via gravity.

Step #2: Set Up Drain Line

The drain line should be routed to a suitable drain on the outside. It must flow down to the drain without any loops, dips, or valleys.

Recommended Drain Option-Transition to PVC Pipe

1. Cut a piece of 3/4” OD PVC that is approx. 6” long.
2. Insert PVC into a 3/4” elbow, then attach to a 3/4” OD length of PVC to drain. (Note: Keep the length of PVC drain pipe to a minimum).
3. Insert the open end of the tubing into the 3/4” pipe so that it does not extend into the elbow fitting. For proper flow, a minimum downward slope of 1” per 10’ run is required. (Note: If a proper downward angle is not possible, then it is recommended to use a Sentinel HDi90 which includes an integrated condensate pump or utilize an external condensate pump).
4. Support the PVC tubing so that it maintains a smooth downward flow to drain.

5. Always test the drain before leaving installation area.

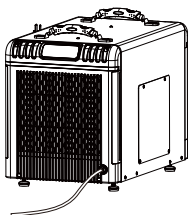

Step #3: Plug unit into 15 amp grounded circuit.

4. Central Control

- This mode is not applicable on the Sentinel HD90
- Central Control light should off at all times when not connected to the AC.

5. Auxillary Terminals A5/A6

- The A5/A6 on the terminal strip can be used as a water level warning switch for external condensate pumps.
If an external pump is connected, the pump must have a self-contained power supply and a water level signal line.

Indicator Lights

1. Humidity Display Screen

- The display screen has two functions:
 1. When the unit is powered on, it shows the humidity of the space.
 2. While setting the desired humidity level, the screen will show the set humidity.
After a brief delay, the display will revert to current humidity level.

2. Power Indicator Light

- This light indicates that the unit is properly powered on and ready to operate. Always make sure this unit is “off” prior to performing any service.
When the power light is blinking, it means that the unit has reached the humidity setpoint.

3. Continuous Mode/Auto Defrost Light

- When this light illuminates green, it indicates that the dehumidifier is set to continuous operation mode.
- When the light glows red, it means the unit is in auto defrost mode and clearing the evaporator coil of any ice buildup.

4. Compressor Light

- When the compressor light glows red, it indicates the compressor has been initiated but is currently warming up.
- Once the compressor light switches to green, it indicates the compressor is in working status.

Remote Control Instructions

Sentinel Dehumidifiers can be controlled using an optional remote accessory. The Sentinel Remote Control connects to your Sentinel Series Dehumidifier via a 25' CAT 5 cable. The remote control contains an integrated sensor which gives you multiple options for remotely controlling your unit, in addition to monitoring the conditions surrounding the dehumidifier.

One application for the remote control is to install the dehumidifier in one room with the conditioned air ducted into a second room that contains the remote. For example, the dehumidifier could be installed in a laundry room and ducted into a living room. The remote would then be mounted in the living room so the remote sensor can control the humidity and provide easy controls for the user.

Another useful application for the remote control is if the dehumidifier is in an area that's difficult to access on a regular basis. For instance, if your dehumidifier is installed in your crawl space, the remote could be mounted in your living space or garage. This provides you with an easy way to monitor the dehumidifier.

NOTE: Symbols indicated below will only appear when the dehumidifier is powered on.

1. On/Off (Power) Button \odot

Press the on/off button and the machine will start running (two beeps). Press the button again to turn the machine off.

2. Up Button \blacktriangle / Down Button \blacktriangledown

Use the Up and Down arrow buttons to adjust the humidity level.

3. Mode M

Use the Mode button to switch between dehumidification and a ducted application.

- The \odot symbol on the display board indicates the sensor on the remote control is being utilized.
- The \blacktriangle symbol on the display board indicates the sensor on the dehumidifier is being utilized.

4. Temperature T

Press the temperature button to display the current temperature on the screen. Press the button again to turn off the display.

5. Continuous C

Press this button to switch the unit into continuous mode. **Cont.** will appear on the display to indicate continuous mode.

6. Drain Pump P

Pressing the drain pump button will remove water from the pump reservoir, so the unit can be safely moved or stored.

NOTE: THIS FUNCTION IS ONLY AVAILABLE ON THE Sentinel HDi90 MODEL.

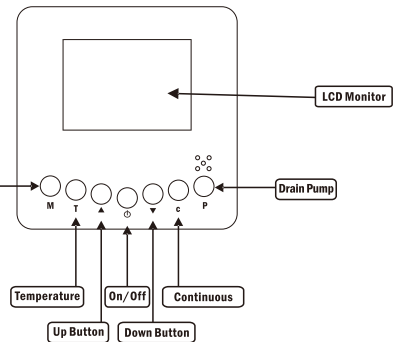

Operating Instructions

1. Start the machine

Press the power key to turn the machine on.

2. Adjust Settings

Use the up and down arrow keys to adjust your desired setpoint (typically 50-55%).

3. Stop the machine

Press the power key again and the machine will stop. The fan will continue to operate for 1 minute after the unit has turned off. NOTE: Do not disconnect power cord to force machine to stop. Always use the power button.

4. Water Drainage

During normal operation, the Sentinel HD90 will automatically drain by the force of gravity. If you want to move or store the machine, wait at least 10 minutes to allow machine to completely defrost, then lean gently towards drain to ensure unit is completely drained.

Sentinel HD90 Diagram

Front View

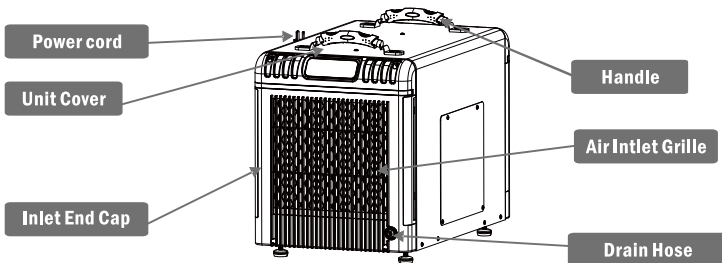

Back View

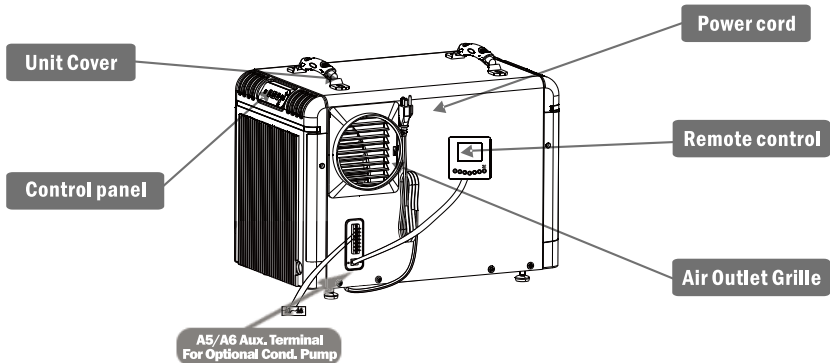

Maintenance

WARNING: Always unplug the unit before doing any maintenance.

Cleaning the machine body

Use a soft damp cloth to clean exterior of unit. Do not use any soap or solvents.

Cleaning the filter

1. Slide out the filter.
2. Clean the filter mesh by vacuuming or washing with warm water (no soap or solvents).
3. Be sure the filter is completely dry before restarting the unit.

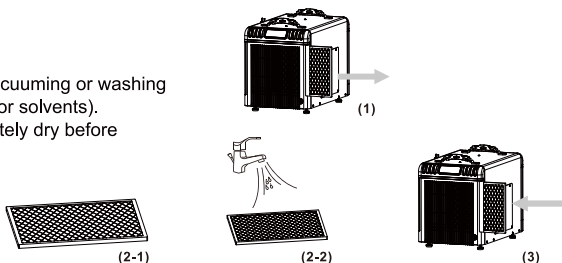

Coil Maintenance

- Once per year, clean the coils with an approved coil cleaner.
- Coil cleaner should be a self rinsing, foaming cleaner such as WEB® Coil Cleaner.

Electrical Access

1. Unscrew the 4 screws on the side panel to access the control board.

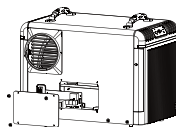

Dehumidifier Storage

If the unit will be stored for an extended period of time, complete the following steps:

1. Turn off the unit and allow to dry.
2. Wrap and secure the power cord.
3. Cover filter mesh.
4. Store in clean, dry space.

Ducted Applications

Ducting the dehumidifier allows the unit to be in one room while conditioning an adjacent room. The inlet/return collar (optional accessory, PN: W-103) is designed for 12" flex ducting while the supply grille is designed for 6" flex ducting.

Be sure to secure the ducting with tie wrap. Also, keep in mind, that the supply ducting can be screwed into an adapter if necessary.

Ducting Installation

- To connect 12" return ducting, it may be helpful to:
 1. Remove inlet grille from end cap.
 2. Connect duct to inlet grille.
 3. Reconnect inlet grille to end cap.

Note: The supply duct adapter is standard on all units. Return duct collar is an optional accessory.

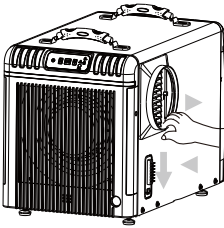

Removing Duct Adapter

If it is necessary to remove the adapter, place hand at bottom of the adapter and use your fingers to pull out and down. This will remove the cover hooks from the machine.

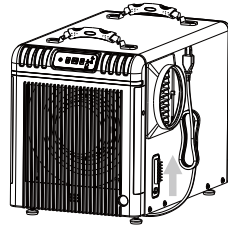

Installing Duct Adapter

To install adapter, line duct up with holes on the side of unit with holes on the side of unit push up from the base of the adapter.

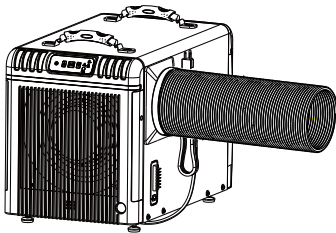

Flex Duct Installation

Rotate the flex duct counter-clockwise.

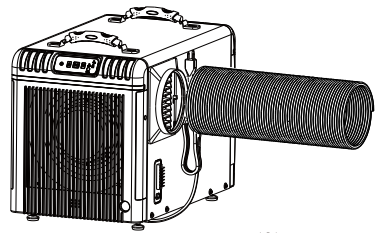

Flex Duct Removal

Rotate flex duct clockwise or remove wire tie.

Troubleshooting

Symptom	Cause	Solution
Machine Won't Run	Power Supply	Verify that there is power to the outlet and that the plug is properly installed in outlet.
	Room Temperature Over 104° F (Display HI) or Below 33.8° F (Display LO)	The unit is outside the operating temperature range. Modify the room conditions so the temperature is between 33.8° – 104° F and operation will commence.
Low Air Flow	Air Filter is Clogged	Clean the filter mesh according to instructions listed in manual.
	Air Inlet or Outlet is Blocked	Clear the blockage from inlet or outlet.
Loud Noise	Machine Is Not Level	Move the dehumidifier to flat, firm ground.
	Filter Mesh is Blocked	Clean the filter mesh according to instructions listed in manual.
Trouble Code E:1	E1=Humidity Sensor Issues	Check to ensure that wire is connected at both ends. If no issues are visible, the sensor may be faulty.
Trouble Code: HI or LO	Room Temperature Over 104° F or Below 33.8° F(Display LO)	The unit is outside the operating temperature range.Modify the room conditions so the temperature is between 33.8° – 104° F and operation will commence.If room conditions are within temperature range,replace defective sensor.
Trouble Code E: 5	Refrigerant Leak	Contact Your Installer for Assistance.

Spare Parts

ALL Sentinel Models-Parts	
Part#	Description
S-100	Remote Control Package(cable+remote)
S-101	Remote Control
S-102	Remote Control Cable,25'
S-103	Return Duct Collar Accessory
S-106	Duct Kit Assembly(W-103+W-100)
S-107	Flexibile Supply Duct,72"
S-108	Main Control Board
S-109	Display Board
S-110	RH/Temperature Sensor
Sentinel HD90-Filters	
Part#	Description
S-915	Prefilter
S-917	MERV-8 Filter

Sentinel HD90-Parts	
Part#	Description
S-900	Fan Motor
S-901	Complete Fan Assembly
S-902	Fan Capacitor
S-903	Compressor
S-904	Compressor Capacitor
S-905	Coil Assembly
S-907	Condensate Pump Assembly
S-908	RH/Temperature Sensor Cable
S-909	Display Cable
S-910	CAT 5 Prot Internal Cable
S-913	Foot,adjustable

Limited Warranty

This limited warranty starts from the date of purchase. Alorair Solutions Inc. warrants to the original purchaser that this ALORAIR product is free from manufacturing defects in material or workmanship for the limited warranty period of:

Six (6) Month parts and labor. This includes the shipments charges for replacement parts or unit.

One (1) year parts and labor. This does not include the shipment charge to send the defective product back to be repaired or replaced.

Three (3) years parts and labor on Refrigeration System ONLY (Compressor, Condenser, and evaporator). Transportation cost, not included.

Five (5) years parts on Refrigeration System ONLY(Compressor, Condenser, and evaporator). Transportation cost, not included.

This limited warranty is valid only on products purchased from the manufacturer or ALORAIR authorized dealer and operated, installed, and maintained according to the instructions included in this user guide or furnished with the product. Alorair Solutions Inc will not provide in-home service during or after the warranty period. You may be responsible for the shipping charge to bring the product to the manufacturer for service.

To receive warranty service, the purchaser must contact ALORAIR at 888-990-7469 or support@alorair.com. A proof of purchase or order number is required to receive warranty service. During the applicable warranty period, a product will be repaired or replaced at the sole option of ALORAIR.

IMPORTANT NOTICE: Keep the item's packaging in case warranty service is required.

Limited Warranty Exclusions

This limited warranty covers manufacturing defects in materials or workmanship encountered in normal household, commercial or noncommercial use of this product and shall not cover the following:

- Damage occurs in uses for which this product was not intended for.
- Damage caused by unauthorized modification or alteration of the product.
- Cosmetic damage including scratches, dents, chips, and other damage to the product's finishes.
- Damage caused by abuse, misuse, pest infestation, accident, fire, floods, or other acts of nature.
- Damage caused by incorrect electrical line current, voltage, fluctuations, and surges.
- Damage caused by failure to perform proper maintenance of the product.

The use of this product in SPA or a room with OUTDOOR POOL invalidate or voids limited warranty.